

## CONVERTIBLE TYPE AIR CONDITIONER OPERATION MANUAL AND INSTALLATION MANUAL

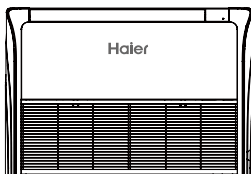

AC35S2SG1FA  
AC50S2SG1FA

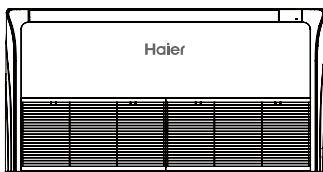

AC71S2SG1FA  
AC90S2SH1FA  
AC105S2SH1FA



AC125S2SK1FA  
AC140S2SK1FA

### Contents



Cautions	6
Move and scrap the air conditioning	10
Safety Precautions	11
Features and Functions	14
Parts and Functions	15
Maintenance	16
Troubleshooting	17
Installation Procedure	21
Test Run	30

No.0150532721

- This product must only be installed or serviced by qualified personnel.  
Please read this manual carefully before installation. This appliance is filled with R32.  
Keep this manual for future reference.  
Original instructions



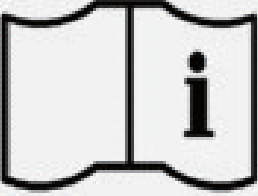

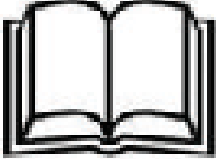
	<p><b>Read the precautions in this manual carefully before operating the unit.</b></p>		<p><b>This appliance is filled with R32.</b></p>
	<p><b>Service indicator; Read technical manual</b></p>		<p><b>Read the operator's manual</b></p>

Keep this manual where the user can easily find it.

## WARNING

- Do not use means to accelerate the defrosting process or to clean, other than those recommended by the manufacturer.
- The appliance must be stored in a room without continuously operating ignition sources (for example: open flames, an operating gas appliance or an operating electric heater).
- Do not pierce or burn.
- Be aware that refrigerants may not contain an odour.
- If the supply cord is damaged, it must be replaced by the manufacturer, its service agent or similarly qualified persons in order to avoid a hazard.
- This appliance can be used by children aged 8 years and above and persons with reduced physical, sensory or mental capabilities or lack of experience and knowledge if they have been given supervision or instruction concerning use of the appliance in a safe way and understand the hazards involved. Children shall not play with the appliance. Cleaning and user maintenance shall not be made by children without supervision.
- The wiring method should be in line with the local wiring standard.
- All the cables shall have got the European authentication certificate. During installation, when the connecting cables break off, it must be assured that the grounding wire is the last one to be broken off. The explosion-proof breaker of the air conditioner should be all-pole switch. Distance between its two contacts should not be no less than 3mm. Such means for disconnection must be incorporated in the wiring.
- Make sure installation is done according to local wiring regulation by professional persons.
- Make sure ground connection is correct and reliable.  
A leakage explosion-proof breaker must be installed.
- Do not use a refrigerant other than the one indicated on the outdoor unit(R32) when installing, moving or repairing. Using other refrigerants may cause trouble or damage to the unit, and personal injury.
- The installation and service of this product shall be carried out by professional personnel, who have been trained and certified by national training organizations that are accredited to teach the relevant national competency standards that may be set in legislation.
- Mechanical connectors used indoors shall comply with ISO 14903. When mechanical connectors are reused indoors, sealing parts shall be renewed. When flared joints are reused indoors, the flare part shall be re-fabricated.
- This appliance is intended to be used by expert or trained users in shops, in light industry and on farms, or for commercial use by lay persons.
- Disconnect the appliance from its power source during service and when replacing parts

---

# WARNING

---

- A brazed, welded, or mechanical connection shall be made before opening the valves to permit refrigerant to flow between the refrigerating system parts. A vacuum valve shall be provided to evacuate the interconnecting pipe and/or any uncharged refrigerating system part.
- The maximum working pressure is 4.3 MPa.
- This maximum working pressure shall be considered when connecting the outdoor unit to indoor unit.
- The refrigerant suitable for the indoor unit is R32 or R410A. The indoor unit shall only be connected to outdoor unit suitable for the same refrigerant.
- The unit is a partial unit air conditioner, complying with partial unit requirements of the International Standard, and must only be connected to other units that have been confirmed as complying to corresponding partial unit requirements of the International Standard.
- The A-weighted sound pressure level is below 70 dB.
- The maximum refrigerant charge amount (kg), and the minimum floor area (m<sup>2</sup>) of the room in which the indoor unit will be installed, are specified in the table on the page 11.
- Pipe-work shall be protected from physical damage and, in the case of flammable refrigerants, shall not be installed in an unventilated space, if the space is smaller than that specified in the table on the page 10
- The installation of pipe-work shall be kept to a minimum.
- Compliance with national gas regulations shall be observed.
- Mechanical connections shall be accessible for maintenance purposes.
- Handling, installation, cleaning, servicing and disposal of refrigerant shall be carried out as per the specifications on the following pages strictly.
- Warning: Keep any required ventilation openings clear of obstruction.
- Notice: Servicing shall be performed only as recommended by this manual instruction.

# Haier

Haier Industrial Park, No.1 Haier road, Qingdao,P.R.China

## EUROPEAN REGULATIONS CONFORMITY FOR THE MODELS

### CE

All the products are in conformity with the following European provision:  
-Low voltage Directive  
-Electromagnetic Compatibility

### ROHS

The products are fulfilled with the requirements in the directive 2011/65/EU of the European parliament and of council on the Restriction of the use of Certain Hazardous Substances in Electrical and Electronic Equipment(EU RoHS Directive)

### WEEE

In accordance with the directive 2012/19/EU of the European parliament,herewith we inform the consumer about the disposal requirements of the electrical and electronic products.

### DISPOSAL REQUIREMENTS:



Your air conditioning product is marked with this symbol.This means that electrical and electronic products shall not be mixed with unsorted household waste.Do not try to dismantle the system yourself:the dismantling of the air conditioning system,treatment of the refrigerant,of oil and of other part must be done by a qualified installer in accordance with relevant local and national legislation.Air conditioners must be treated at a specialized treatment facility for reuse, recycling and recovery.By ensuring this product is disposed of correctly,you will help to prevent potential negative consequences for the environment and human health.Please contact the installer or local authority for more information. Battery must be removed from the remote controller and disposed of separately in accordance with relevant local and national legislation.

## IMPORTANT INFORMATION REGARDING THE REFRIGERANT USED

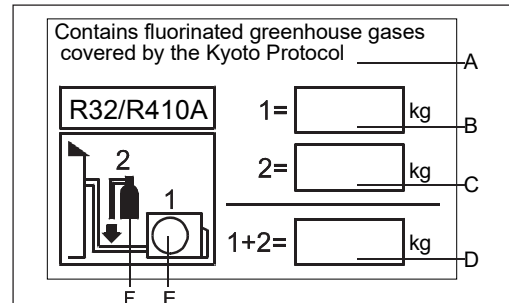

This product contains fluorinated greenhouse gases covered by the Kyoto Protocol.Do not vent into the atmosphere.

Refrigerant type:R32 GWP:675  
Refrigerant type:R410A GWP:2088

GWP=global warming potential

Please fill in with indelible ink,

- 1 the factory refrigerant charge of the product
  - 2 the additional refrigerant amount charged in the field and
  - 1+2 the total refrigerant charge on the refrigerant charge label supplied with the product. The filled out label must be adhered in the proximity of the product charging port(e.g.onto the inside of the stop value cover).
- A contains fluorinated greenhouse gases covered by the Kyoto Protocol  
B factory refrigerant charge of the product:see unit name plate  
C additional refrigerant amount charged in the field  
D total refrigerant charge  
E outdoor unit  
F refrigerant cylinder and manifold for charging

## ⚠ WARNING

If the supply cord is damaged, it must be replaced by the manufacturer, its service agent or similarly qualified persons in order to avoid a hazard.

This appliance is not intended for use by persons (including children) with reduced physical, sensory or mental capabilities, or lack of experience and knowledge, unless they have been given supervision or instruction concerning use of the appliance by a person responsible for their safety.

Children should be supervised to ensure that they do not play with the appliance.

This appliance can be used by children aged from 8 years and above and persons with reduced physical, sensory or mental capabilities or lack of experience and knowledge if they have been given supervision or instruction concerning use of the appliance in a safe way and understand the hazards involved. Children shall not play with the appliance. Cleaning and user maintenance shall not be made by children without supervision.

The appliances are not intended to be operated by means of an external timer or separate remote-control system.

Keep the appliance and its cord out of reach of children less than 8 years.

# Cautions

---

## **Disposal of the old air conditioner**

Before disposing an old air conditioner that goes out of use, please make sure it's inoperative and safe. Unplug the air conditioner in order to avoid the risk of child entrapment.

It must be noticed that air conditioner system contains refrigerants, which require specialized waste disposal. The valuable materials contained in a air conditioner can be recycled. Contact your local waste disposal center for proper disposal of an old air conditioner and contact your local authority or your dealer if you have any question. Please ensure that the pipework of your air conditioner does not get damaged prior to being picked up by the relevant waste disposal center, and contribute to environmental awareness by insisting on an appropriate, anti-pollution method of disposal.

## **Disposal of the packaging of your new air conditioner**

All the packaging materials employed in the package of your new air conditioner may be disposed without any danger to the environment.

The cardboard box may be broken or cut into smaller pieces and given to a waste paper disposal service. The wrapping bag made of polyethylene and the polyethylene foam pads contain no fluorochloric hydrocarbon.

All these valuable materials may be taken to a waste collecting center and used again after adequate recycling.

Consult your local authorities for the name and address of the waste materials collecting centers and waste paper disposal services nearest to your house.

## **Safety Instructions and Warnings**

Before starting the air conditioner, read the information given in the User's Guide carefully. The User's Guide contains very important observations relating to the assembly, operation and maintenance of the air conditioner.

The manufacturer does not accept responsibility for any damages that may arise due to non-observation of the following instruction.

- Damaged air conditioners are not to be put into operation. In case of doubt, consult your supplier.
- Use of the air conditioner is to be carried out in strict compliance with the relative instructions set forth in the User's Guide.
- Installation shall be done by professional people. Don't install unit by yourself.
- For the purpose of safety, the air conditioner must be properly grounded in accordance with specifications.
- Always remember to unplug the air conditioner before opening inlet grill. Always grip plug firmly and pull straight out from the outlet.
- All electrical repairs must be carried out by qualified electricians. Inadequate repairs may result in a major source of danger for the user of the air conditioner.
- Do not damage any parts of the air conditioner that carry refrigerant by piercing or perforating the air conditioner's tubes with sharp or pointed items, crushing or twisting any tubes, or scraping the coatings off the surfaces. If the refrigerant spurts out and gets into eyes, it may result in serious eye injuries.
- Do not obstruct or cover the ventilation grille of the air conditioner. Do not put fingers or any other things into the inlet/outlet and swing louver.
- Do not allow children to play with the air conditioner. In no case should children be allowed to sit on the outdoor unit.
- When the indoor unit is turned on, the PCB will test if swing motor is O.K., and then fan motor will start up. So there is a few seconds to wait.
- In cooling mode, the flaps will swing automatically to a fixed position for anti-condensating.
- This appliance is not intended for use by persons (including children) with reduced physical, sensory or mental capabilities, or lack of experience and knowledge, unless they have been given supervision or instruction concerning use of the appliance by a person responsible for their safety.
- Children should be supervised to ensure that they do not play with the appliance.

# Cautions

---

- The installation of pipe-work shall be kept to a minimum.
- Pipe-work shall be protected from physical damage and shall not be installed in an unventilated space, if that space is smaller than Amin(2m<sup>2</sup>).
  - Compliance with national gas regulations shall be observed.
  - Mechanical connections shall be accessible for maintenance purposes.
- The minimum floor area of the room: 2 m<sup>2</sup>.
  - The maximum refrigerant charge amount: 1.7 kg.
  - Information for handling, installation, cleaning, servicing and disposal of refrigerant.
  - Warning: Keep any required ventilation openings clear of obstruction.
  - Notice: Servicing shall be performed only as recommended by the manufacturer.

## Unventilated areas

- Warning: The appliance shall be stored in a well-ventilated area where the room size corresponds to the room area as specified.
- Warning: The appliance shall be stored in a room without continuously operating open flames (e.g. an operating gas appliance) and ignition sources (e.g. an operating electric heater).

## Qualification of workers

- Specific information about the required qualification of the working personnel for maintenance, service and repair operations.
  - Warning: Every working procedure that affects safety means shall only be carried out by competent persons.
- Examples for such working procedures are:
- breaking into the refrigerating circuit.
  - opening of sealed components
  - opening of ventilated enclosures.

## Information on servicing

- Prior to beginning work on systems, safety checks are necessary to ensure that the risk of ignition is minimized.
- Work shall be undertaken under a controlled procedure so as to minimize the risk of flammable gas or vapor being present while the work is being performed.
- Work in confined spaces shall be avoided. The area around the workspace shall be sectioned off. Ensure that the conditions within the area have been made safe by control of flammable material.

## Checking for presence of refrigerant

- The area shall be checked with an appropriate refrigerant detector prior to and during work. The leak detection equipment should be suitable for use with all applicable refrigerants, i.e. non-sparking, adequately sealed or intrinsically safe.

## Presence of fire extinguisher

- If any hot work is to be conducted, appropriate fire extinguishing equipment shall be available to hand. Have a dry powder or CO<sub>2</sub> fire extinguisher adjacent to the charging area.

## No ignition sources

- All possible ignition sources, including cigarette smoking, should be kept sufficiently far away from the site of installation, repairing, removing and disposal. Prior to work taking place, the area around the equipment is to be surveyed to make sure that there are no flammable hazards or ignition risks. "No Smoking" signs shall be displayed.

## Ventilated area

- Ensure that the area is in the open or that it is adequately ventilated before breaking into the system or conducting any hot work. A degree of ventilation shall continue during the period that the work is carried out. The ventilation should safely disperse any released refrigerant and preferably expel it externally into the atmosphere.

## Checks to the refrigeration equipment

- Where electrical components are being changed, they shall be fit for the purpose and to the correct specification. At all times the manufacturer's maintenance and service guidelines shall be followed. If in doubt, consult the manufacturer's technical department for assistance.

## The following checks shall be applied to installations

- The charge size is in accordance with the room size within which the refrigerant containing parts are installed;
- The ventilation machinery and outlets are operating adequately and are not obstructed;
- If an indirect refrigerating circuit is being used, the secondary circuit shall be checked for the presence of refrigerant;
- Marking to the equipment continues to be visible and legible. Markings and signs that are illegible shall be corrected;
- Refrigeration pipe or components are installed in a position where they are unlikely to be exposed to any substance which may corrode refrigerant containing components, unless the components are constructed of materials which are inherently resistant to being corroded or are suitably protected against being so corroded.

# Cautions

---

## Checks to electrical devices

- Repair and maintenance to electrical components shall include initial safety checks and component inspection procedures. If a fault exists that could compromise safety, then no electrical supply shall be connected to the circuit until it is satisfactorily dealt with. If the fault cannot be corrected immediately but it is necessary to continue operation, an adequate temporary solution shall be used. This shall be reported to the owner of the equipment so all parties are advised.

- Initial safety checks shall include:
  - that capacitors are discharged: this shall be done in a safe manner to avoid possibility of sparking;
  - that no live electrical components and wiring are exposed while charging, recovering or purging the system;
  - that there is continuity of earth bonding.

## Repairs to sealed components

- During repairs to sealed components, all electrical supplies shall be disconnected prior to any removal of sealed covers, etc. If it is absolutely necessary to have an electrical supply to equipment during servicing, then a permanently operating form of leak detection shall be located at the most critical point to warn of a potentially hazardous situation.

- Ensure that by working on electrical components, the casing is not altered in such a way that the level of protection is affected, including damage to cables, excessive number of connections, terminals not made to original specification, damage to seals, incorrect fitting of glands, etc.

- Ensure that the apparatus is mounted securely.

- Ensure that seals or sealing materials have not degraded to the point that they no longer serve the purpose of preventing the ingress of flammable atmospheres. Replacement parts shall be in accordance with the manufacturer's specifications.

## Repair to intrinsically safe components

- Do not apply any permanent inductive or capacitance loads to the circuit without ensuring that this will not exceed the permissible voltage and current permitted for the equipment in use.

- Intrinsically safe components are the only types that can be worked on while live in the presence of a flammable atmosphere.

- Replace components only with parts specified by the manufacturer. Other parts may result in the ignition of refrigerant in the atmosphere from a leak.

## Cabling

- Check that cabling will not be subject to wear, corrosion, excessive pressure, vibration, sharp edges or any other adverse environmental effects. The check shall also take into account the effects of aging or continual vibration from sources such as compressors or fans.

## Detection of flammable refrigerants

### Removal and evacuation

- The refrigerant charge shall be recovered into the correct recovery cylinders and the system shall be "flushed" with OFN to render the unit safe. This process may need to be repeated several times.

- Compressed air or oxygen shall not be used for purging refrigerant systems.

- Flushing shall be achieved by breaking the vacuum in the system with OFN and continuing to fill until the working pressure is achieved, then venting to atmosphere, and finally pulling down to a vacuum. This process shall be repeated until no refrigerant is within the system. When the final OFN charge is used, the system shall be vented down to atmospheric pressure to enable work to take place.

- The vacuum pump is not close to any ignition sources and that ventilation is available.

## Charging procedures

- Ensure that contamination of different refrigerants does not occur when using charging equipment. Hoses or lines shall be as short as possible to minimise the amount of refrigerant contained in them.

- Cylinders shall be kept upright.

- Ensure that the refrigeration system is earthed prior to charging the system with refrigerant.

- Label the system when charging is complete (if not already).

- Extreme care shall be taken not to overfill the refrigeration system.

- Prior to recharging the system, it shall be pressure-tested with the appropriate purging gas. The system shall be leak-tested on completion of charging but prior to commissioning. A follow up leak test shall be carried out prior to leaving the site.

## Decommissioning

- Before carrying out this procedure, it is essential that the technician is completely familiar with the equipment and all its detail.

- Prior to the task being carried out, an oil and refrigerant sample shall be taken in case analysis is required prior to re-use of reclaimed refrigerant.

- Electrical power must be available before the task is commenced.



# Cautions

---

- Become familiar with the equipment and its operation.
  - Isolate system electrically.
  - Before attempting the procedure, ensure that:
    - mechanical handling equipment is available, if required, for handling refrigerant cylinders;
    - all personal protective equipment is available and being used correctly;
    - the recovery process is supervised at all times by a competent person;
    - recovery equipment and cylinders conform to the appropriate standards.
  - Pump down refrigerant system, if possible.
  - If a vacuum is not possible, make a manifold so that refrigerant can be removed from various parts of the system.
  - Make sure that cylinder is situated on the scales before recovery takes place.
  - Start the recovery machine and operate in accordance with manufacturer's instructions.
  - Do not overfill cylinders. (No more than 80 % volume liquid charge).
  - Do not exceed the maximum working pressure of the cylinder, even temporarily.
  - When the cylinders have been filled correctly and the process completed, make sure that the cylinders and the equipment are removed from site promptly and all isolation valves on the equipment are closed off.
    - Recovered refrigerant shall not be charged into another refrigeration system unless it has been cleaned and checked.

## Labelling

- Equipment shall be labelled stating that it has been de-commissioned and emptied of refrigerant. The label shall be dated and signed.
  - Ensure that there are labels on the equipment stating the equipment contains flammable refrigerant.

## Recovery

- When transferring refrigerant into cylinders, ensure that only appropriate refrigerant recovery cylinders are employed.
  - Ensure that the correct number of cylinders for holding the total system charge are available. All cylinders to be used are designated for the recovered refrigerant and labelled for that refrigerant (i.e. special cylinders for the recovery of refrigerant).
    - Cylinders shall be complete with pressure-relief valve and associated shut-off valves in good working order. Empty recovery cylinders are evacuated and, if possible, cooled before recovery occurs.
    - The recovery equipment shall be in good working order with a set of instructions concerning the equipment that is at hand and shall be suitable for the recovery of all appropriate refrigerants.
    - A set of calibrated weighing scales shall be available and in good working order. Hoses shall be complete with leak-free disconnect couplings and in good condition. Before using the recovery machine, check that it is in satisfactory working order, has been properly maintained and that any associated electrical components are sealed to prevent ignition in the event of a refrigerant release.
    - The recovered refrigerant shall be returned to the refrigerant supplier in the correct recovery cylinder, and the relevant waste transfer note arranged.
      - Do not mix refrigerants in recovery units and especially not in cylinders.
  - If compressors or compressor oils are to be removed, ensure that they have been evacuated to an acceptable level to make certain that flammable refrigerant does not remain within the lubricant.
- The evacuation process shall be carried out prior to returning the compressor to the suppliers.
  - Only electric heating to the compressor body shall be employed to accelerate this process.

# Cautions

---

## Specifications

- The refrigerating circuit is leak-proof.
- For all the models in this manual, the all-pole disconnection connection method should be applied in the power supply. Such means for disconnection must be incorporated in the fixed wiring.

## Temperature and Humidity Range

Cooling	Indoor temperature	max. DB/WB min. DB/WB	32/23°C 18/14°C
	Outdoor temperature	max. DB/WB min. DB/WB	46/26°C 10/6°C
Heating	Indoor temperature	max. DB/WB min. DB/WB	27°C 15°C
	Outdoor temperature	max. DB/WB min. DB/WB	24/18°C -15°C

- If the air conditioner is used under higher temperature condition than those listed, the built-in protection circuit may operate to prevent internal circuit damage. Also, during Cooling and Dry modes, if the unit is used under conditions of lower temperature than those listed above, the heat-exchanger may freeze, leading to water leakage and other damage.
- Do not use this unit for purposes other than cooling, heating, dehumidifying and ventilation of rooms in ordinary dwellings.
- The wiring method should be in line with the local wiring standard.
- The waste battery should be disposed properly.
- If the fuse on PC board is broken, please change it with the type T 3.15A/250VAC.

## Move and scrap the air conditioning

---

- When moving, to disassemble and re-install the air conditioning, please contact your dealer for technical support.
- In the composition material of air conditioning, the content of lead, mercury, hexavalent chromium, polybrominated biphenyls and polybrominated diphenyl ethers are not more than 0.1% (mass fraction) and cadmium is not more than 0.01% (mass fraction).
- Please recycle the refrigerant before scrapping, moving, setting and repairing the air conditioning; for the air conditioning scrapping, should be dealt with by the qualified enterprises.













# Safety Precautions

- Before starting to use the system, read carefully this "SAFETY PRECAUTIONS" to ensure a proper operation of the system.
- Safety precautions described here are classified to " ⚠ WARNING" and " ⚠ CAUTION". Precautions which are shown in the column of " ⚠ WARNING" means that an improper handling could lead to a grave result like a death, serious injury, etc. However, even if precautions are shown in the column of " ⚠ CAUTION", a very serious problem could occur depending on situation. Make sure to observe these safety precautions faithfully because they are very important information to ensure the safety.
- Symbols which appear frequently in the text have following meanings.

	Strictly prohibited.		Observe instructions faithfully.		Provide a positive grounding.
---	----------------------	---	----------------------------------	---	-------------------------------

- When you have read through the manual, keep it always at hand for read consultation. If the operator is replaced, make sure to hand over this manual to the new operator.

## CAUTIONS FOR INSTALLATION

⚠ WARNING		
<p>The system should be applied to places as office, restaurant, residence and the like.</p>  <p>Application to inferior environment such as an engineering shop, could cause equipment malfunction and serious injury or death.</p>	<p>The system should be installed by your dealer or a professional installer.</p>  <p>Installation by yourself is not encouraged because it could cause such problems as water leakage, electrical shock or fire accident by some improper handling.</p>	<p>When you need some optional devices such as a humidifier, electric heater, etc., be sure to use the products which are recommended by us. These devices should be attached by a professional installer.</p>  <p>Installation by yourself is not encouraged because it could cause such problems as water leakage, electrical shock or fire accident by some improper handling.</p>
⚠ CAUTION		
<p>Do not install nearby the place where may have leakage of flammable gas.</p>   <p>If the gas leaks and gathers around, it may cause the fire.</p>	<p>Depending on the place of installation, a circuit breaker may be necessary.</p>   <p>Unless the circuit breaker is installed, it could cause electrical shocks.</p>	<p>Drain pipe should be arranged to provide a positive draining.</p>   <p>If the pipe is arranged improperly, furniture or the likes may be damaged by leaked water.</p>
<p>Where strong winds may prevail, the system should be fixed securely to prevent a collapse.</p>  <p>Bodily injury could result by a collapse.</p>	<p>Install on the place where can endure the weight of air conditioner.</p>  <p>Bodily injury could result by a careless installation.</p>	<p>Make sure the system is grounded.</p>   <p>Grounding cable should never be connected to a gas pipe, city water pipe, lightning conductor rod or grounding cable of telephone. If the grounding cable is not set properly, it could cause electric shocks.</p>

### • Installation Precautions

#### WARNING!



- ★ The area of the room in which R32 refrigerant air conditioner is installed cannot be less than the minimum area specified in the table below, to avoid potential safety problems due to out-of-limit of refrigerant concentration inside the room caused by leakage of refrigerant from refrigeration system of the indoor unit.
- ★ Once the horn mouth of connecting lines is fastened, it may not be used again (the air tightness may be affected).
- ★ A whole connector wire shall be used for indoor/outdoor unit as required in the operation specification of installation process and operation instructions.

#### Minimum Room Area













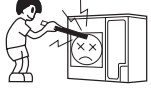



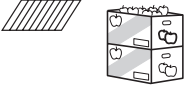



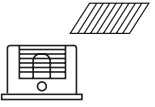







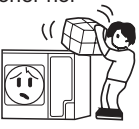



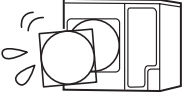

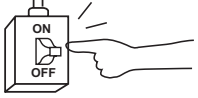

Type	LFL kg/m <sup>3</sup>	hv m	Total Mass Charged/kg Minimum Room Area/m <sup>2</sup>						
			1.224	1.836	2.448	3.672	4.896	6.12	7.956
R32	0.306	0.6		29	51	116	206	321	543
		1.0		10	19	42	74	116	196
		1.8		3	6	13	23	36	60
		2.2		2	4	9	15	24	40

# Safety Precautions

## CAUTIONS FOR TRANSFER OR REPAIR

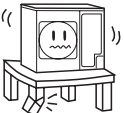
⚠ WARNING	
<p>Modification of the system is strictly prohibited. When the system needs a repair, consult your dealer.</p> <p></p> <p>Improper practice of repair could cause water leakage, electric shock or fire.</p>	<p>When the air conditioner is relocated, contact your dealer or a professional installer.</p> <p></p> <p>Improper practice of installation could cause water leakage, electric shock or fire.</p>

## CAUTIONS FOR OPERATION

⚠ WARNING		
<p>You should refrain from exposing your body directly to cool wind for a long time.</p> <p> </p> <p>It could affect your physical condition or cause some health problems.</p>	<p>Do not poke the air inlet or outlet with a bar, etc.</p> <p> </p> <p>Since the internal fan is operating with a high speed, it could cause an injury.</p>	<p>When any abnormal condition (scorching smell or others) is found, stop the operation immediately and turn off the power switch. Then consult your dealer.</p> <p> </p> <p>If you continue the operation without removing the cause, it could result in a trouble, electric shock or fire.</p>
⚠ CAUTION		
<p>The system should never be used for any other purposes than intended such as for preservation of food, flora and fauna, precision devices or work of art.</p> <p> </p> <p>It could cause deterioration of food or other problems.</p>	<p>Do not handle switches with a wet hand.</p> <p> </p> <p>It could cause electric shocks.</p>	<p>Combustion apparatus should not be placed allowing a direct exposure to wind of air conditioner.</p> <p> </p> <p>Incomplete combustion could occur on the apparatus.</p>
<p>Do not wash the air conditioner with water.</p> <p> </p> <p>It could cause electric shocks.</p>	<p>Do not install the system where the air outlet reaches directly the flora and fauna.</p> <p> </p> <p>It will not be good for their health.</p>	<p>Make sure to use a fuse of proper electric rating.</p> <p> </p> <p>Use of steel or copper wire in place of a fuse is strictly prohibited because it could result in a trouble or fire accident.</p>
<p>Neither stand on the air conditioner nor place something on it.</p> <p> </p> <p>There are risks of falling or injury by collapsed object.</p>	<p>It is strictly prohibited to place a container of combustible gas or liquid near the air conditioner or to spray it directly with the gas or liquid.</p> <p> </p> <p>It could cause a fire accident.</p>	<p>Do not operate the system while the air outlet grill is removed.</p> <p> </p> <p>There is a risk of injury.</p>
<p>Do not use the power switch to turn on or off the system.</p> <p> </p> <p>It could cause a fire or water leakage.</p>	<p>Do not touch the air outlet section while the swing louver is operating.</p> <p> </p> <p>There is a risk of injury.</p>	<p>Do not use such equipment as a water heater, etc. around the indoor unit or the wire controller.</p> <p> </p> <p>If the system is operated at the vicinity of such equipment which generates steam, condensed water may drip during cooling operation or it could cause a fault current or short-circuit.</p>
<p>When operating the system simultaneously with a combustion apparatus, indoor air must be ventilated frequently.</p> <p> </p> <p>Insufficient ventilation could cause an oxygen deficiency accident.</p>	<p>Check occasionally the support structure of the unit for any damage after a use of long period of time.</p> <p> </p> <p>If the structure is not repaired immediately, the unit could topple down to cause a personal injury.</p>	<p>When cleaning the system, stop the operation and turn off the power switch.</p> <p> </p> <p>Cleaning should never be done while the internal fans are running with high speed.</p>
<p>Do not put water containers on the unit such as a flower vase, etc.</p> <p></p> <p>If the water enters into the unit and damages the electric insulation material, it may cause electric shock.</p>		

# Safety Precautions

---

## WARNING

- The breaker of the air conditioner should be all-pole switch, and the distance between its two contacts should be no less 3 mm. Such means for disconnection must be incorporation in the fixed wiring.
- Use copper wire only. All the cables shall have got the European authentication certificate.
- The power supply connects from the outdoor side. The connecting cable and the power cable are self-provided.
- The parameter of connecting cable: H05RN-F 4G 0.75mm<sup>2</sup>.

## DANGER

- Do not attempt to install this air conditioner by yourself.
- This unit contains no user-serviceable parts. Always consult authorized service personnel for repairs.
- When moving, consult authorized service personnel for disconnection and installation of the unit.
- Do not become excessively chilled by staying for lengthy periods in the direct cooling airflow.
- Do not insert fingers or objects into the outlet port or intake grills.
- Do not start and stop air conditioner operation by connecting and disconnecting the power supply cord and so on.
- Take care not to damage the power supply cord. If the supply cord is damaged, it must be replaced by the manufacturer or authorized service agent in order to avoid a hazard.
- In the event of a malfunction (burning smell, etc.), stop operation immediately, turn off the circuit breaker, and consult authorized service personnel.

## WARNING

- Provide occasional ventilation during use.
- Do not direct air flow at fire places or heating apparatuses.
- Do not place objects on the air conditioner or climb onto it .
- Do not hang objects from the indoor unit.
- Do not set flower vases or water containers on top of the air conditioner.
- Do not expose the air conditioner directly to water.
- Do not operate the air conditioner with wet hands.
- Do not pull power supply cord.
- Turn off power source when not using the unit for extended periods.
- Check the condition of the installation stand for damage.
- Do not place animals or plants in the direct path of the air flow.
- Do not drink the water drained from the air conditioner.
- Do not use in applications involving the storage of foods, plants or animals, precision equipment or art works.
- Do not apply any heavy pressure to radiator fins.
- Operate only with air filters installed.
- Do not block or cover the intake grill and outlet port.
- Ensure that any electronic equipment is at least one metre away from either the indoor or outdoor unit.
- Avoid installing the air conditioner near a fireplace or other heating apparatuses.
- When installing the indoor and outdoor unit, take precautions to prevent access to infants.
- Do not use inflammable gases near the air conditioner.

# Features and Functions

---

## **AUTOMATIC OPERATION**

### • COOLING TYPE

Merely press the ON/OFF button, and the unit will begin automatic operation in the Cooling or dry modes as appropriate, in accordance with the thermostat setting and the actual temperature of the room.

### • HEAT & COOL TYPE

Merely press the ON/OFF button, and the unit will begin automatic operation in any of the Heating, Cooling and Blow modes as appropriate, in accordance with the thermostat setting and the actual temperature of the room.

## **SLEEP**

### • COOLING TYPE

When the SLEEP button is pressed during Cooling or Dry mode, the thermostat setting gradually rises during the period of operation. When the set time is reached, the unit automatically turns off.

### • HEAT & COOL TYPE

When the SLEEP button is pressed during Heating mode, the air conditioner's thermostat setting gradually lowers during the period of operation; When the set time is reached, the unit automatically turns off.

## **WIRELESS REMOTE CONTROL UNIT**

- The WIRELESS REMOTE CONTROL UNIT allows convenient control of air conditioner operation. For this type unit, the wireless remote controller type is YR-H50.

## **MILDEW-RESISTANT FILTER**

- The AIR FILTER has been treated to resist mildew growth, thus allowing cleaner use and easier care.

# Parts and Functions

## Indoor Unit

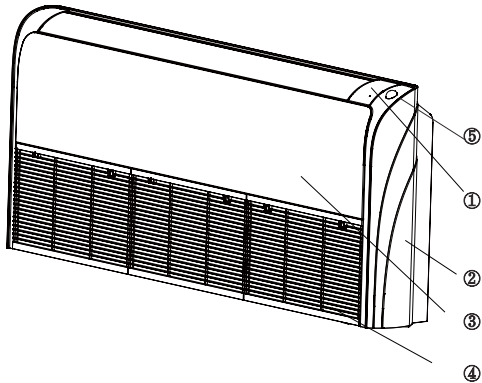

### Operating Control Panel 1

- (1) Operation Control Panel
- (2) Cover Plate
- (3) Front Panel
- (4) Inlet Grill(Filter inside)
- (5) Human Sensor
- (6) RUNNING Indicator Lamp
- (7) TIMER Indicator Lamp
- (8) POWER Indicator Lamp
- (9) Emergency Switch
- (10) Remote Receiver

### Operating Control Panel 1

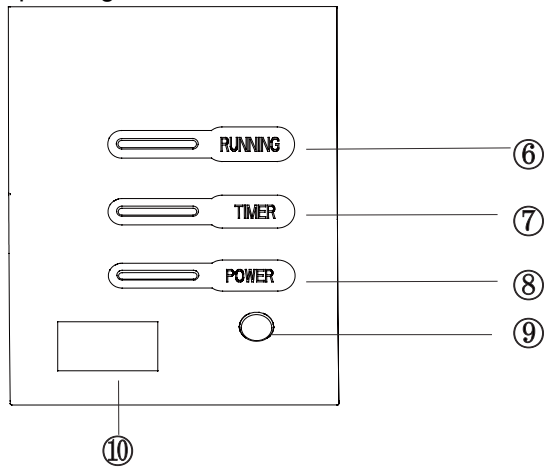

### Operating Control Panel 2

- (1) Operation Control Panel
- (2) Cover Plate
- (3) Front Panel
- (4) Inlet Grill(Filter inside)
- (5) Human Sensor
- (6) WIFI Indicator Lamp
- (7) Display Indicator Lamp
- (8) Emergency Switch
- (9) Remote Receiver

### Operating Control Panel 2

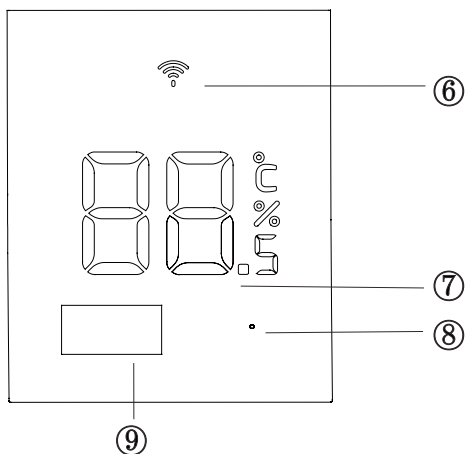

### Note:

For the wired control type unit, the unit state should be checked by the wired controller, instead of the remote receiver.

And if you set the TIMER function, the TIMER LED on the remote receiver will not be on.

2.The different PANEL for different models.

# Parts and Functions

---

## "HOT KEEP" function

"HOT KEEP" is operated in the following cases.

- When heating is started:  
In order to prevent blowing out of cool wind, the indoor unit fan stopped according to the room temperature which heating operation is started. Wait for approx. 2 to 3 minute, and the operation will be automatically changed to the ordinary heating mode.
- Defrosting operation (in the heating mode):  
When it is liable to frost, the heating operation is stopped automatically for 5 to 12 minutes once per approx. one hour, and defrosting is operated. After defrosting is completed, operation mode is automatically changed to ordinary heating operation.
- When the room thermostat is actuated:  
When room temperature increases and room temperature controller actuates, the fan speed is automatically changed to stop under low temperature condition of indoor heat exchanger. When room temperature decreases, air conditioner automatically changes over to ordinary heating operation.



## Warming operation

- Heat pump type warming  
With the heat pump type warming, the mechanism of heat pump that concentrate heat of outdoor air with the help of refrigerant to warm the indoor space, is utilized.
- Defrosting operation  
When a room is warmed with a heat pump type air conditioner, frost accumulates on the heat exchanger of outdoor unit along with the drop of indoor temperature. Since the accumulated frost reduces the effect of warming, it is necessary to automatically switch the operation to the defrosting mode. During the defrosting operation, heating operation is interrupted.
- Atmospheric temperature and warming capacity  
Warming capacity of heat pump type air conditioner decreases along with the drop of outdoor temperature. When the warming capacity is not sufficient, it is recommended to use another heating implement.
- Period of warm-up  
Since the heat pump type air conditioner employs a method to circulate warm winds to warm the entire space of a room, it takes time before the room temperature rises. It is recommendable to start the operation a little earlier in a very cold morning.

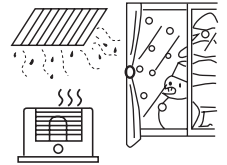

# Maintenance

---

## Clean the air filter

1. Pull the filters upward to remove them from the Intake Grill.
2. Clean the air filter: Remove the dust from the filters by vacuum cleaner or washing them. After washing, allow the air filters to dry thoroughly in an area protected from sunlight.
3. Re-attach the air filters to the Intake Grill. Press the two buttons on the filters until you hear a sound of click.

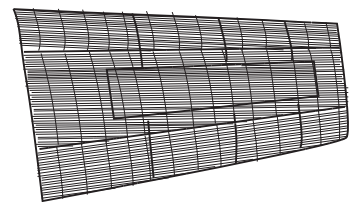





## Maintenance of indoor units

- When used for extended periods, the unit may accumulate dirt inside, which reduces its performance. We recommend that the unit is inspected regularly, in addition to your own cleaning and care. For more information, consult authorized service personnel.
- When cleaning the unit's body, do not use water hotter than 40°C, harsh abrasive cleansers, or volatile agents like benzene or thinner.
- Do not expose the unit body to liquid insecticides or hairsprays.
- When shutting down the unit for one month or more, first allow the Fan mode to operate continuously for about half a day to allow internal parts to dry thoroughly.



# Troubleshooting

## Followings are not problems

<p>Sound of water flowing is not a problem.</p> 	<p>During unit operation or at stop, a swishing or gurgling noise may be heard. This noise is generated by refrigerant flowing in the system.</p>
<p>Sound of cracking is heard.</p>	<p>During unit operation, a cracking noise may be heard. This noise is generated by the casing expanding or shrinking because of temperature changes.</p>
<p>Smell are generated.</p>	<p>This is because the system circulates smells from the interior air such as the smell of cigarettes or the painting on the furniture.</p>
<p>During operation, white fog or steam comes out from the indoor unit.</p>	<p>When unit is running at places like restaurant, etc. where dense edible oil fumes always exist, this will happen.</p>
<p>In cooling operation, unit switches to blowing operation.</p>	<p>To prevent frost from accumulating on indoor heat exchanger, unit will switch to blowing operation for a while then resume cooling operation.</p>
<p>Unit will not restart after stop.</p> <p>Won't start?</p> 	<p>Though ON/OFF button is set to ON, the unit won't resume cooling, dry or heating operation in 3 min after it is stopped, this is because of 3-min-delay protection circuit.</p>  <p>Please wait 3 minutes</p>
<p>No outlet air or fan speed can't be changed in dry mode.</p>	<p>Unit will reduce fan speed repeatedly and automatically if room temp. is too low in dry operation.</p>
<p>In heating operation, water or steam are blown out of outdoor unit.</p> 	<p>This occurs when frost accumulated on the outdoor unit is removed. (during defrosting operation)</p> 
<p>In heating operation, indoor fan won't stop even if unit is stopped.</p>	<p>After unit stop, indoor fan will go on running until indoor unit cools down.</p>

# Troubleshooting

Before ask for services, please first check your unit against the following.

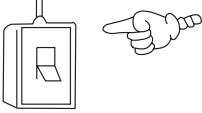
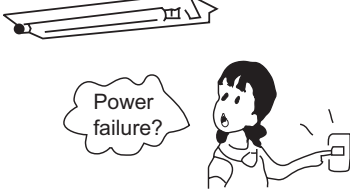
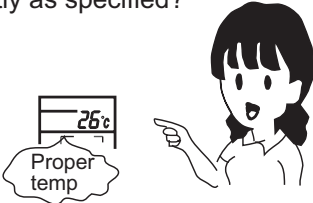
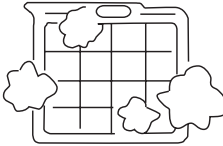
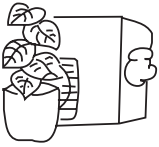
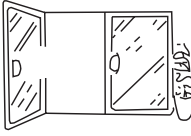
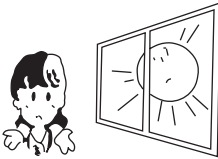
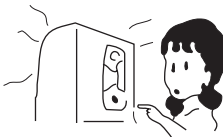
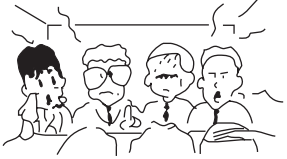
Air conditioner won't start.		
<p>Is power supply switch turned on?</p>  <p>Power supply switch is not set at ON.</p>	<p>Is city power supply normal?</p>  <p>Power failure?</p>	<p>Is leakage current breaker activated?</p> <p>This is very dangerous, please disconnect power supply immediately and contact your dealer.</p>
Poor cooling or heating		
<p>Are operation control adjusted correctly as specified?</p>  <p>Proper temp</p>	<p>Is air filter too dirty?</p> 	<p>Are there any obstacles in inlet or outlet grill?</p> 
<p>Are horizontal louvers at up position (in heating mode)?</p>	<p>Any doors or windows left open?</p> 	
Poor cooling		
<p>Is there any direct sunlight in the room?</p> 	<p>If there are unexpected heat sources in the room?</p> 	<p>Too many people in the room?</p> 
<p>Cold air blows out (in heating mode). Is air conditioner in standby condition in heating mode?</p>		

If your unit still can't work properly after above mentioned checks, or following problems occur, please stop it immediately and contact your dealer.

- Fuses or circuit breakers often blow out.
- Water comes out in cooling/dry operation.
- Operation is abnormal or sound is heard.

# Troubleshooting

When failure happens, the fan of indoor unit stop running. The method of check failure code as follow.

For outdoor failure, the failure code is outdoor failure LED flash times + 20.

For example, the failure code of outdoor unit is 2. the wired controller of indoor unit will display 16 (using hexadecimal method).

Ta: ambient temperature sensor

Tm: coil temperature sensor

OUTDOOR UNIT TROUBLE SHOOTING			
Error code	Malfunction Description	Diagnosis and Analysis.	Remark
1	EEPROM malfunction	EEPROM chip damaged or data wrong or related circuit damaged.	Non-resumable
2	PIM (power intelligent module) hardware over current	Input over current occurred been detected by PIM's hardware.	Resumable
3	Compressor over current during deceleration	Over current occurred during compressor deceleration period.	Non-resumable
4	Communication abnormal between control board and compressor driver module	Control board can not communicating with compressor driver module over 4 minutes	Resumable
5	Compressor overcurrent detected by control board	Compressor over current been detected by control board	Non-resumable
6	DC voltage or AC voltage high	AC power supply of the driver module get voltage over 280VAC or driver module get high DC-BUS voltage over 390VDC.	Resumable
7	Compressor current sampling circuit fault	The driver module's Compressor current sampling circuit damaged.	Non-resumable
8	Discharge temperature too high protection	Compressor discharge temperature over 115°C, error clear within 3 minutes if temperature goes down and lower than 115°C. Error status lock if it occurs 3 times in 1 hour.	Non-resumable
9	DC fan motor fault	DC fan motor damage or not connected or related circuit broken. Error status confirm and lock if occurs 3 times within 30 minutes.	Non-resumable
10	Outdoor defrosting temp. sensor Te abnormal	Sensor temperature been detected below -55°C or higher than 90°C or been detected as short circuit or open circuit..	Resumable
11	Suction temp. sensor Ts abnormal		
12	Outdoor ambient temp. sensor Ta abnormal	Sensor temperature been detected below -40°C or higher than 90°C or been detected short circuit or open circuit.	Resumable
13	Discharging temp. sensor Td abnormal	Sensor temperature been detected below -40°C or higher than 150°C or been detected short circuit or open circuit .	Resumable
14	PFC circuit loop high voltage	Overvoltage been detected in driver module's power factor correction circuit loop.	Resumable
15	Communication abnormal between indoor unit and outdoor unit	Outdoor unit control board can not communicating with indoor unit control board over 4 minutes.	Resumable
16	Lack of refrigerant or discharging pipe blocked	Discharge & suction temperature $T_d - T_s \geq 80^\circ\text{C}$ after compressor started 10 minutes. Error status lock if it occurs 3 times in 1 hour.	Non-resumable
17	4-way valve converse abnormal	Indoor pipe & indoor ambient temperature $T_m - T_{ai} \geq 5^\circ\text{C}$ after compress- or started 10 minutes. Error status lock if it occurs 3 times in 1 hour.	Non-resumable
18	Compressor motor desynchronizing	Rotor desynchronizing occurred, caused by overload or load sharply fluctuating or compressor current sensor circuit abnormal or one of the inverter's gate drive signal missing.	Non-resumable

# Troubleshooting

Error code	Malfunction Description	Diagnosis and Analysis	Remark
19	DC voltage or AC voltage low	AC power supply of the driver module get voltage lower than 155VAC or driver module get high DC-BUS voltage lower than 180VDC.	Resumable
20	Indoor pipe temperature too high protection	Indoor pipe temperature Tm over 63°C, error clear within 3 minutes if temperature goes down and lower than 52°C.	Resumable
21	Indoor pipe sensor temperature too low protection	Indoor pipe temperature too low, outdoor unit stop to prevent indoor heat exchange system icing and to prevent the indoor unit outlet air too low at the same time	Resumable
22	PFC circuit loop overcurrent	Overcurrent been detected in power factor correction circuit loop.	Resumable
23	Temperature too high for compressor driver module	Compressor driver module's PIM temperature over 90°C, Error stat-us lock if it occurs 3 times in 1 hour.	Non-resumable
24	Compressor start failure	Compressor start failure been detected by driver driver module.	Non-resumable
25	Input overcurrent of the drive module	Input current of the compressor drive module higher than 32A (double fan model) or 27A (single fan) , Lock if it occurs 3 times in 1 hour.	Non-resumable
26	Lack phase of the drive module	Lack phase of the drive module's power supply.(three phase type)	Non-resumable
27	Input current sampling circuit fault	The driver module's input current sampling circuit damaged.	Resumable
28	No wiring of the compressor	No wiring between compressor and it's driver module.	Non-resumable
37	Compressor overcurrent detected by compressor driver module	Compressor phase U or V or W current over 27A (single phase model) or 19.1A (single phase model) occured during non-rated period.	Resumable
38	Drive module's ambient temp. sensor abnormal	The temperature detected is not within the range of -25°C to 150 °C.	Resumable
39	Mid-condenser temp. sensor TC abnormal	The temperature detected is not within the range of -55°C to 90 °C.	Resumable
42	High pressure switch abnormal	After compressor running for 3 minutes, switch been detected open circuit for 30seconds, Error lock if it occurs 3 times in 1 hour.	Non-resumable
43	Low pressure switch abnormal	After compressor running for 3 minutes, switch been detected uncon-nected for 60seconds or unconnected for 30seconds at standby.	Non-resumable
44	Outdoor condenser temperatureTC too high protection	The maximum temperature value of Tc and Te is over 65 °C, Error lock if it occurs 3 times in 30 minutes.	Non-resumable
45	System low pressure protection	The minimum temperature value of indoor pipe Tm and outdoorTs is lower than-45 °C at cooling mode or minimum temperature value of outdoor Tc and outdoor Te is lower than-45 °C.	Non-resumable

## Note:

1. The outdoor control board's LED3 indicates the outdoor error code. for example, the error code 12, LED3 will display 12 and keep flashing.
2. NO-resumable means error will not clear unless: a. clean out the fault factor b. Cut the power supply off and reoffer again after point a achieved.
3. The indoor unit can also indictes the outdoor malfunction code too. Please refer to indoor unit manul to get the method.

# Installation Procedure

---

Please ask the dealer or specialist to install, never try by the users themselves. After the installation please be sure of the following conditions.

## WARNING

- **Please call dealer to install the air-conditioner. Incorrect installation may cause water leaking, shock and fire hazard.**

## CAUTION

- **Air-conditioner can't be installed in the environment with inflammable gases because the inflammable gases near air-conditioner may cause fire hazard.**

- **Installed electrical-leaking circuit breaker.**

It easily cause electrical shock without circuit breaker.

- **Connect earthing wire.**

Earthing wire should not be connected to the gas pipe, water pipe, lightning rod or phone line, incorrect earthing may cause shock.



- **Use discharge pipe correctly to ensure efficient discharge.**

Incorrect pipe use may cause water leaking.

- **Wiring**

Air-conditioner should be equipped with special power supply wire.

- **Location**

- Air-conditioner should be located in well-vented and easily accessible place.

- Air-conditioner should not be located in the following places:

- (1) Places with machine oils or other oil vapours.
- (2) Seaside with high salt content in the air.
- (3) Near hot spring with high content of sulfide gases.
- (4) Area with frequent fluctuation of voltage e.g. factory, etc.
- (5) In vehicles or ships.
- (6) Kitchen with heavy oil vapour or humidity.
- (7) Near the machine emitting electric-magnetic waves.
- (8) Places with acid, alkali vapour.

- Choose the following locations:

- (1) Capable of supporting air conditioner weight. Don't increase operating noise and vibration.
- (2) Hot vapour from outdoor unit outlet and operating noise don't disturb neighbour.
- (3) No obstacles around the outdoor unit outlet.

- TV, radio, acoustic appliances etc. are at least 1 m far away from the indoor unit, outdoor unit, power supply wire, connecting wire, pipes, otherwise images may be disturbed or noises be created.

- As required, take measures against heavy snow.

## For authorized service personnel only

## WARNING

- (1) For the room air conditioner to operate satisfactorily, install it as outlined in this installation manual.
- (2) Connect the indoor unit and outdoor unit with the room air conditioner piping and cords available from our standard parts. This installation manual describes for the correct connections so that the installation set available from our standard parts should be used.
- (3) Installation work must be performed in accordance with national wiring standards by authorized personnel only.
- (4) Never cut the power cord, lengthen or shorten the cord, or change the plug. Do not use an extension cord.
- (5) Plug in the power cord plug firmly. If the receptacle is loose, repair it before using the room air conditioner.
- (6) Do not turn on the power until all installation work is done.

## CAUTION

- (1) Be careful not to scratch the room air conditioner when handling it.
- (2) After installation, explain correct operation to the customer, according to the operating manual.
- (3) Let the customer keep this installation manual because it will be used when the room air conditioner is serviced or moved.

# Installation Procedure

## SELECTING THE MOUNTING POSITION

### WARNING

- Install at a place that can withstand the weight of the indoor unit and install it positively so that the unit will not topple or fall.

### CAUTION

- Do not install the unit where there is the danger of combustible gas leakage.
- Do not install near heat sources.
- If children under 10 years old may approach the unit, take preventive measures so that they cannot reach the unit.

### Decide the mounting position with the customer as follows.

- (1) Install the indoor unit level on a strong wall which is not subject to vibration.
- (2) The inlet and outlet ports should not be obstructed, and the air should be able to blow all over the room.
- (3) Do not install the unit where it will be exposed to direct sunlight
- (4) Install the unit where connection to the outdoor unit is easy.
- (5) Install the unit where the drain pipe can be easily installed.
- (6) Take servicing, etc. into consideration and leave the spaces shown in "Maintenance space dimension" .
- (7) Install the unit where the filter can be removed

## ACCESSORIES FOR INSTALLATION

The following installation parts are optional parts. Use them as required.

Optional parts

Adhesive tape
Saddle (L.S) with screws
Drain hose
Heat insulation material
Piping hole cover
Putty
Plastic clamp

## MAINTENANCE SPACE DIMENSION

### For ceiling installation

Ceiling

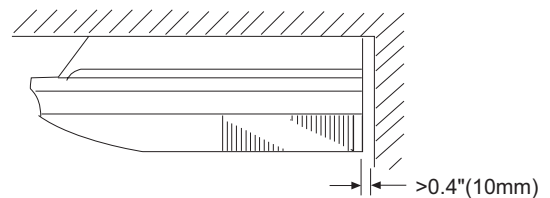
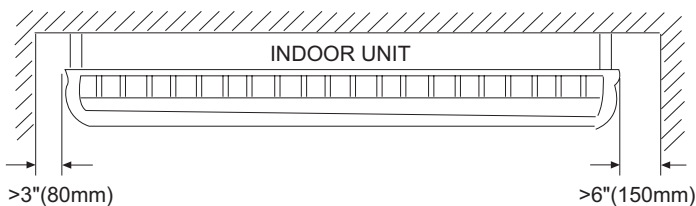

### For half concealed installation

Ceiling panel

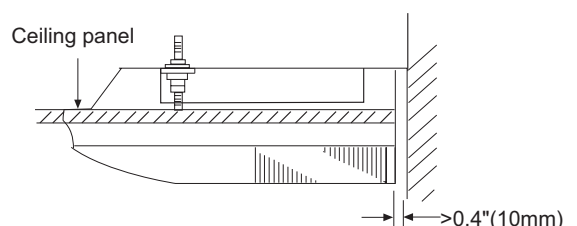
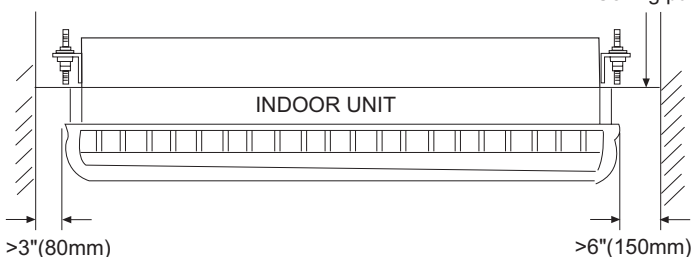

# Installation Procedure

## INSTALLING THE INDOOR UNIT

### Connection pipe requirement

Model	Diameter		Maximum length	Maximum height (between indoor and outdoor)
	Liquid side	Gas side		
AC35S2SG1FA	6.35mm	9.52mm	15m	10m
AC50S2SG1FA	6.35mm	12.7mm	20m	10m
AC71S2SG1FA	9.52mm	15.88mm	20m	10m
AC90S2SH1FA AC105S2SH1FA AC125S2SK1FA	9.52mm	15.88mm	30m	20m
AC140S2SK1FA	9.52mm	15.88mm	50m	30m

### Install the room air conditioner as follows

#### 1. Remove the intake grill and side cover

- (1) Open the intake grill
- (2) Remove the Side cover(Right and left side)
- (3) This air conditioner can be set up to intake fresh air. The information about how to install for fresh-air intake, refer to "Fresh air intake".

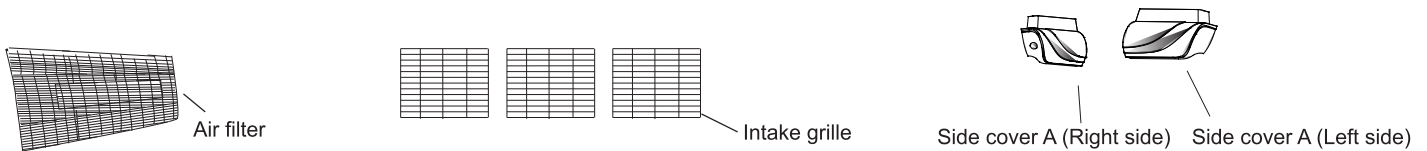

#### Open the intake grill

- (1) Push the embedding switch according to the direction of the arrowhead.(Refer to Fig.1)
- (2)Turn into the intake grill according to the direction of the arrowhead.(Refer to Fig.2)

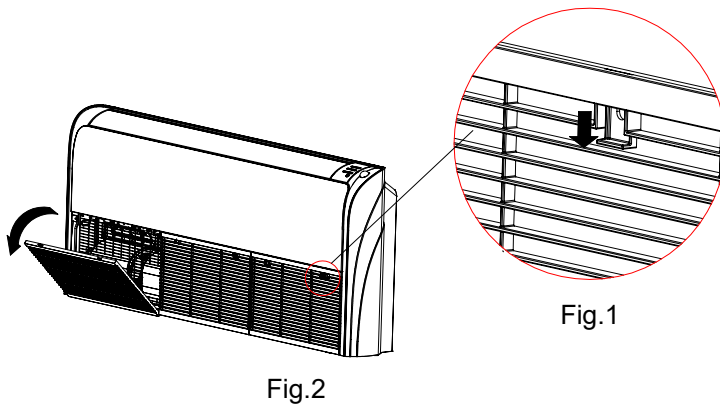

#### Remove the Side cover

- (1) Remove the screw.
- (2) Push the Side cover according to the direction of the arrowhead.
- (3) Then remove the Side cover.

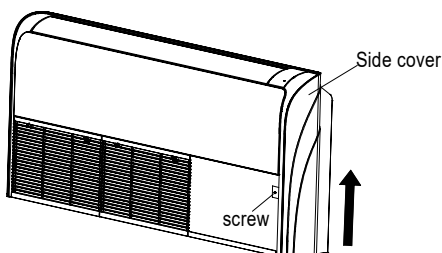

# Installation Procedure

## Cut intake grill for drain pipe

(1) Tools: Knife or Pliers.

(2) Cut the intake grill before installing the drain pipe, Then, pass the drain pipe through the hole. As the following schematic.

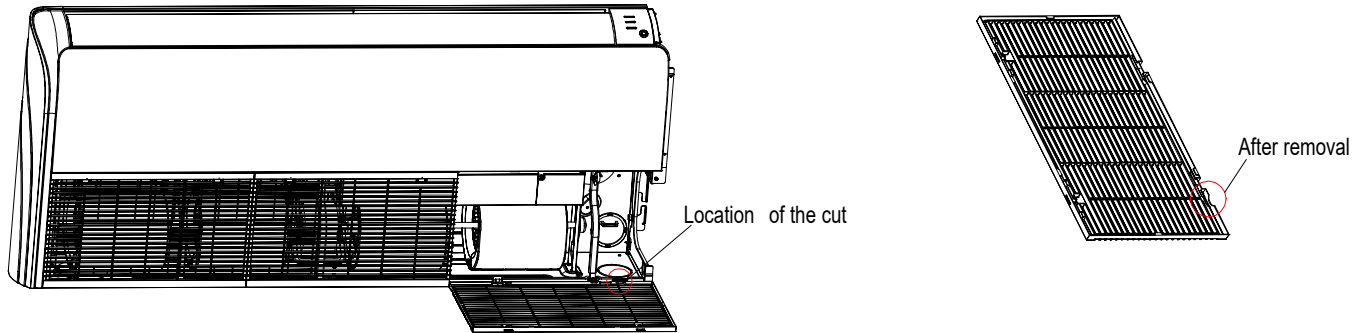

## Installing the drain pipe and the connecting pipe

(1) When the unit is installed in the ceiling, Installing them as below.

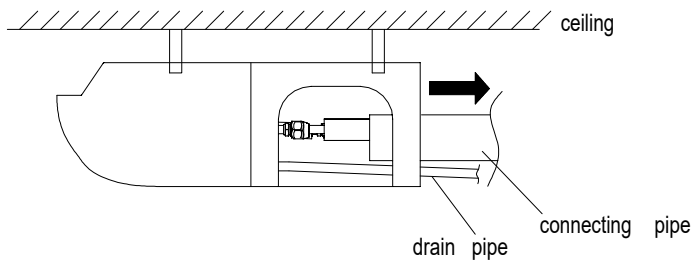

(2) When the unit is installed on the floor, Installing them as below.

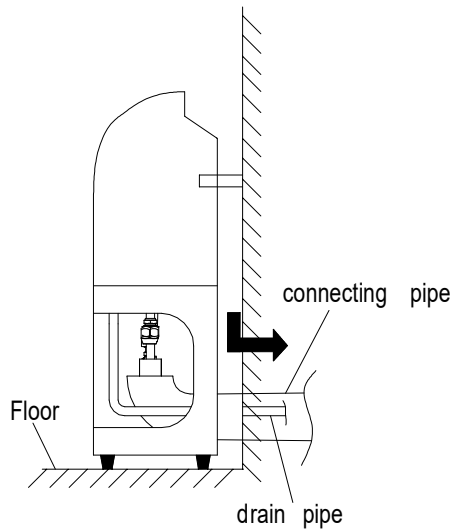

## CAUTION

When the unit is installed in the ceiling, side B is lower than side A for condensate discharge. As below.

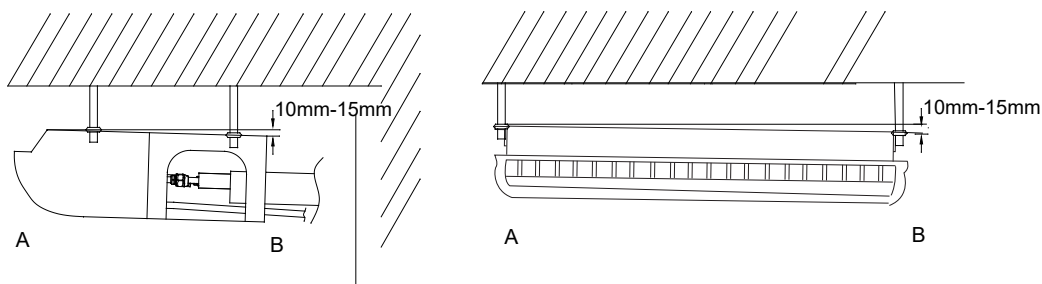



# Installation Procedure

## 2. Location of ceiling suspension bolts

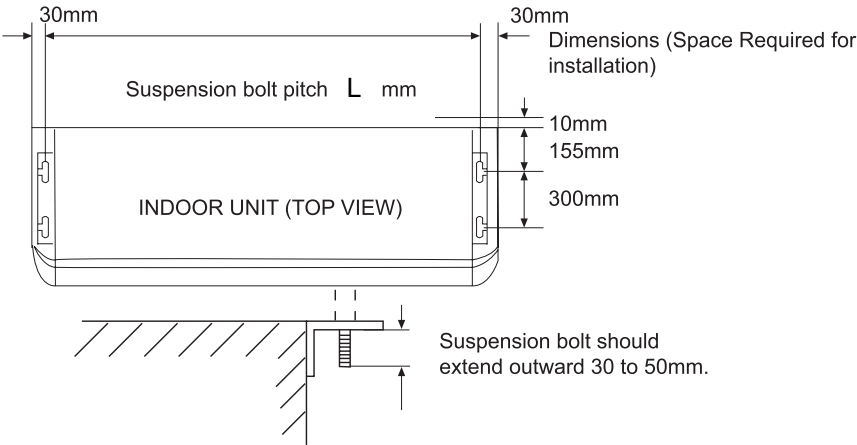

MODEL	L
00H1 ÙGÙÖF00ZÁ 00I1 €ÙGÙÖF00ZÁ	880
00I1 FÙGÙÖF00ZÁ 00J1 €ÙGÙP00ZÁ 00F1 ÙGÙP00ZÁ	1204
00F1 ÙGÙS00ZÁ 00I1 €ÙGÙS00ZÁ	1530

### For half-concealed installation

Suspension-bolt pitch should be as shown below

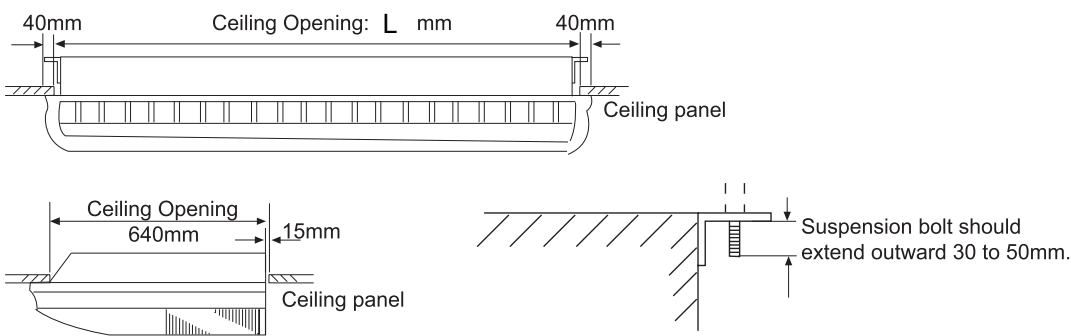

## 3. Drilling the holes and attaching the suspension bolts

- (1) Drill  $\phi 25$ mm holes at the suspension-bolt locations. The two special nuts are provided with the unit. The M10 nut must be obtained locally.
- (2) Install the bolts, then temporarily attach Special nuts A and B and a normal M10 nut to each bolt.

*Bolt strength: 980 to 1470 N (100 TO 150 kgf)*

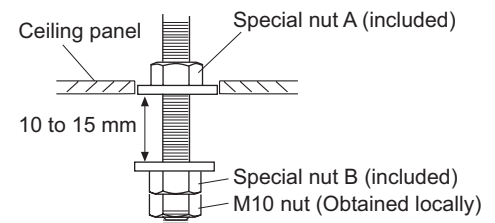

### If using anchor bolts

- (1) Drill holes for anchor bolts at the locations at which you will set the suspension bolts. Note that anchor bolts must be obtained locally.
- (2) Install the anchor bolts, then temporarily attach special nut "B" (included) and a locally-procured M10 nut to each of the bolts.

*Anchor-bolt strength: 980 to 1470 N (100 TO 150 kgf)*

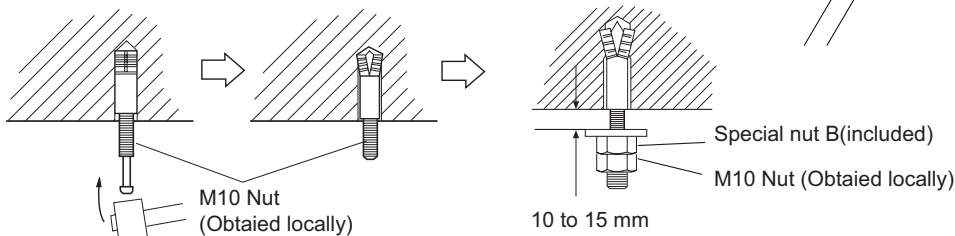

# Installation Procedure

## 4. Installing the indoor unit

- (1) Lift unit so that suspension bolts pass through suspension fittings at the sides (four places), and slide the unit back.
- (2) Fasten the indoor unit into place by tightening-up the special "B" bolts and the M10 nuts. Make sure that unit is secure and will not shift back and forth.

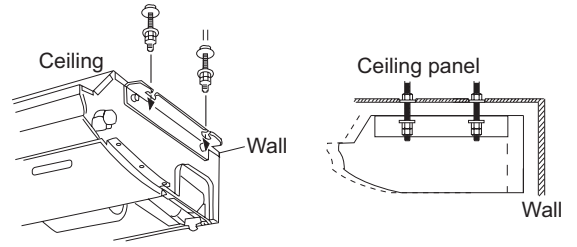

### For half-concealed installation

When installing the indoor unit in a semi-concealed orientation, make sure to reinforce the insulation of the unit on all sides. Drops of water may fall from the unit if it is not thoroughly insulated.

### CAUTION

In order to check the drainage, be sure to use a level during installation of the indoor unit. If the installation site of the indoor unit is not level, water leakage may occur.

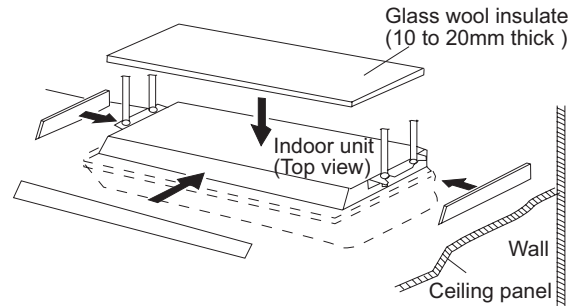

## 5. Installing the coupler heat insulation

After checking for gas leaks, insulate by wrapping insulation around the two parts (large and small) of the indoor unit coupling, using the coupler heat insulation. After installing the coupler heat insulation, wrap both ends with vinyl tape so that there is no gap. Secure both ends of the heat insulation material using nylon fasteners.

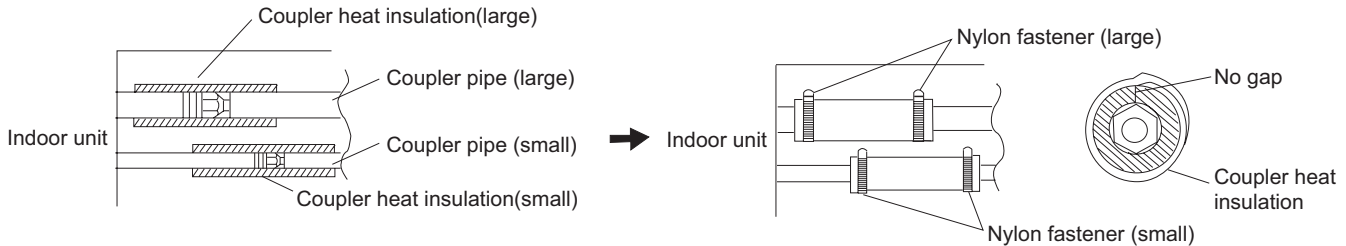

When using an auxiliary pipe, make sure that the fastener used is insulated in the same way.

### Note:

When installing the unit on the floor, fix the four rubber base feet in the accessories on the bottom plate of the unit with four 4x16 screws and 4 flat washers, as the position in the figure.

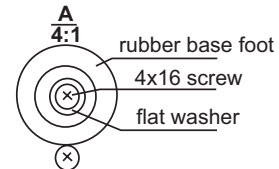
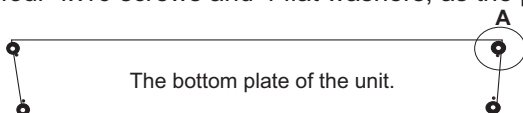

# Installation Procedure

## INSTALLING THE DRAIN HOSE

- Install the drain pipe with downward gradient (1/50 to 1/100) and so there are no rises or traps in the pipe.
- Use general hard polyvinyl chloride pipe (VP25) (outside diameter 38 mm)
- During installation of the drain pipe, be careful to avoid applying pressure to the drain point of the unit.
- When the pipe is long, install supporters.
- Do not perform air bleeding.
- Always heat insulate (8mm or over thick) the indoor side of the drain pipe.

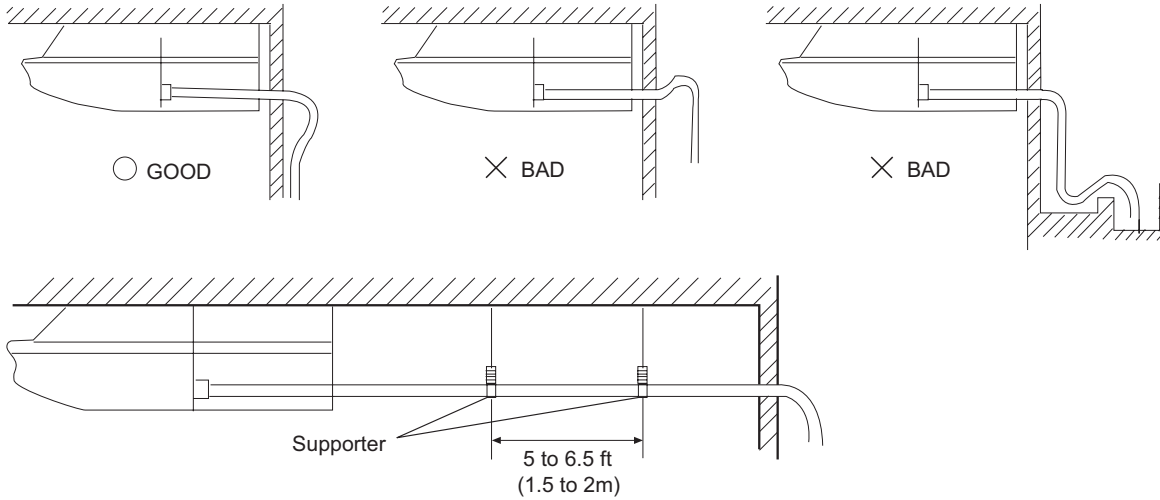

## Install insulation for the drain pipe

Cut the included insulation material to an appropriate size and adhere it to the pipe.

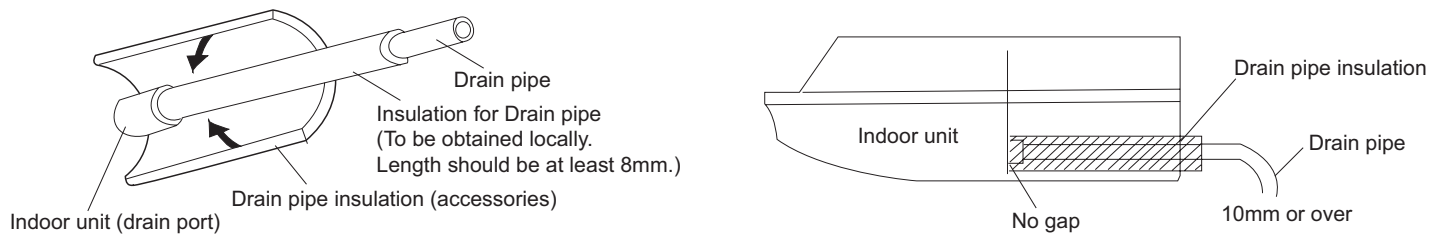

## ELECTRICAL WIRING

### A. Connect wiring to the terminals

(1) Remove the screw

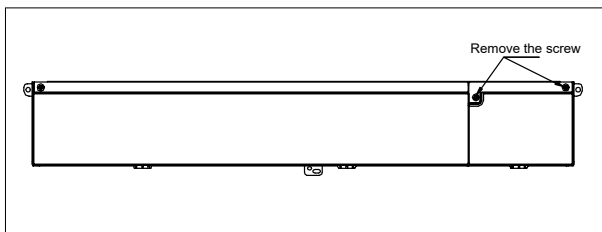

(2) Remove the cover

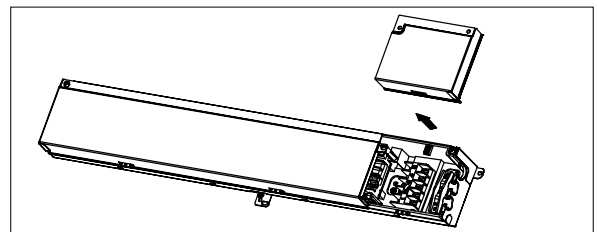

(3) Connect the wiring

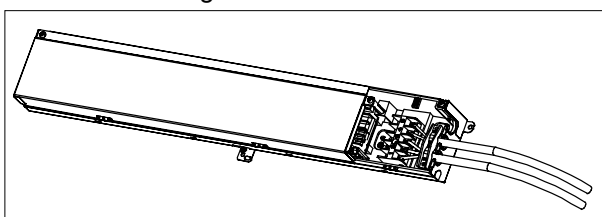

# Installation Procedure

## B. For solid core wiring (or F-cable)

- (1) Cut the wire end with a wire cutter or wire-cutting pliers, then strip the insulation to about 15/16"(25mm) to expose the solid wire.
- (2) Using a screwdriver, remove the terminal screw(s) on the terminal board.
- (3) Using pliers, bend the solid wire to form a loop suitable for the terminal screw.
- (4) Shape the loop wire properly, place it on the terminal board and tighten securely with the terminal screw using a screwdriver.

## C. For strand wiring

- (1) Cut the wire end with a wire cutter or wire-cutting pliers, then strip the insulation to about 3/8"(10mm) to expose the solid wire.
- (2) Using a screwdriver, remove the terminal screw(s) on the terminal board.
- (3) Using a round terminal fastener or pliers, securely clamp a round terminal to each stripped wire end.
- (4) Position the round terminal wire, and replace and tighten the terminal screw using a screwdriver.

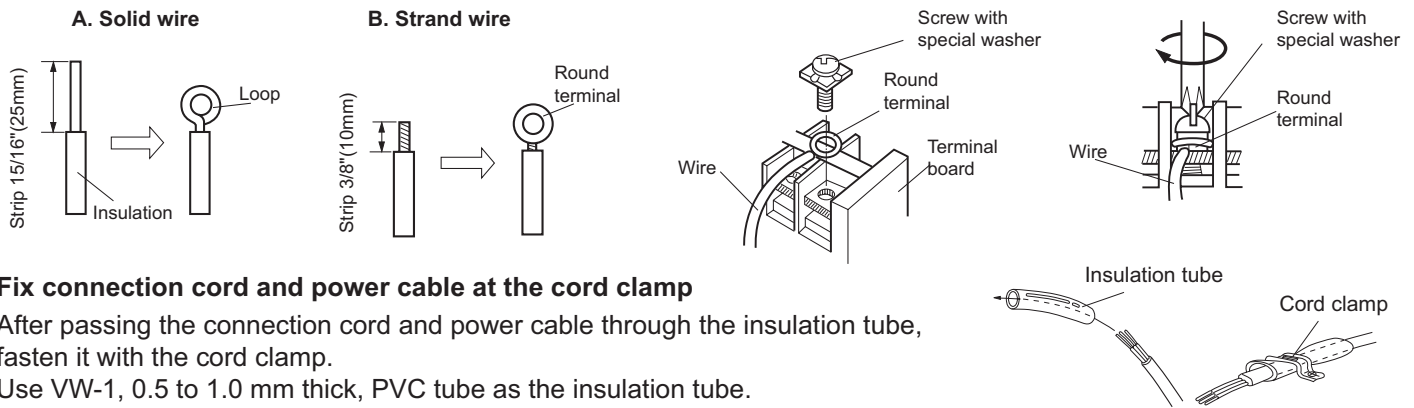

## Fix connection cord and power cable at the cord clamp

After passing the connection cord and power cable through the insulation tube, fasten it with the cord clamp.

Use VW-1, 0.5 to 1.0 mm thick, PVC tube as the insulation tube.

## Electrical requirement

Select wire sizes and circuit protection from table below. (This table shows 20m length wires with less than 2% voltage drop).

## CAUTION

- Match the terminal block numbers and connection cord colors with those of the outdoor unit. Erroneous wiring may cause burning the electric parts.
- Connect the connection cords firmly to the terminal block. Imperfect installation may cause a fire.
- Always fasten the outside covering of the connection cord with the cord clamp. If the insulator is chafed, electric leakage may occur.
- Always connect the ground wire.
- **The Unit has default temperature compensation setting, please cancel it when floor standing installation.**

## Connect indoor unit and outdoor unit

- (1) Remove the cord clamp.
- (2) Process the end of the connection cords to the dimensions shown in wiring diagram.
- (3) Connect the end of the connection cord fully into the terminal block.
- (4) Fasten the connection cord with a cord clamp.
- (5) Fasten the end of the connection cord with the screw.

# Installation Procedure

## Wiring diagram

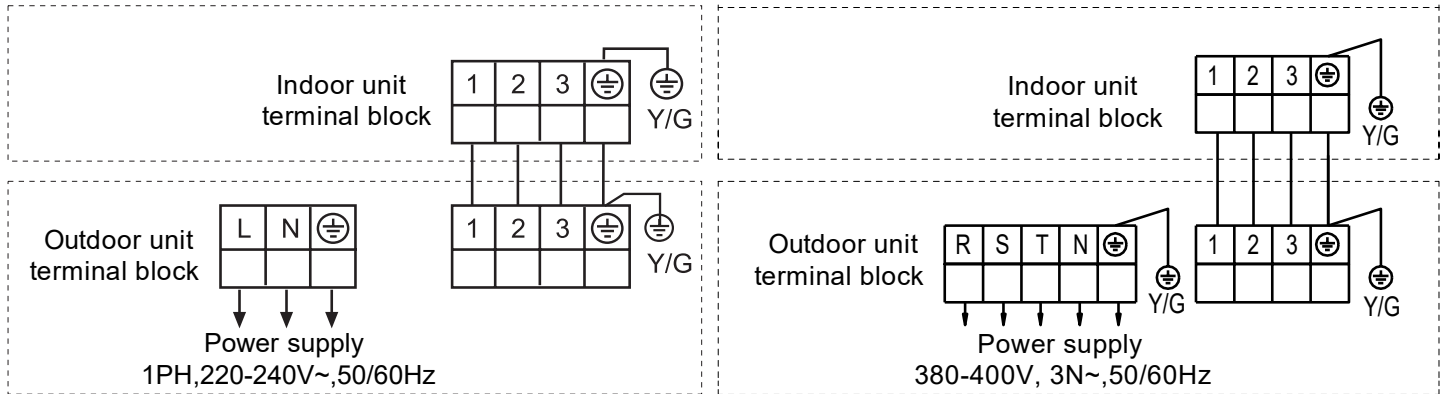

The specification of cable between indoor unit to outdoor unit is HO5RN-F4G 2.5mm<sup>2</sup>

## WARNING

- The power cable and connecting cable are self-provided.
- Always use a special branch circuit and install a special receptacle to supply power to the room air conditioner.
- Use a circuit breaker and receptacle matched to the capacity of the room air conditioner.
- The circuit breaker is installed in the permanent wiring. Always use a circuit that can trip all the poles of the wiring and has an isolation distance of at least 3mm between the contacts of each pole.
- Perform wiring work in accordance with standards so that the room air conditioner can be operated safely and positively.
- Install a leakage circuit breaker in accordance with the related laws and regulations and electric company standards.

## CAUTION

- The power source capacity must be the sum of the room air conditioner current and the current of other electrical appliances. When the current contracted capacity is insufficient, change the contracted capacity.
- When the voltage is low and the air conditioner is difficult to start, contact the power company the voltage raised.

## FRESH AIR INTAKE

1. Open up the knockout hole for the fresh air intake. If using half-concealed installation, open up the top knockout hole instead.

## CAUTION

- When removing the cabinet (iron plate), be careful not to damage the indoor unit internal parts and surrounding area (outer case).
- When processing the cabinet (iron plate), be careful not to injury yourself with burrs, etc.

2. Fasten the round flange (optional) to the fresh air intake. If using half-concealed installation, attach to the top.

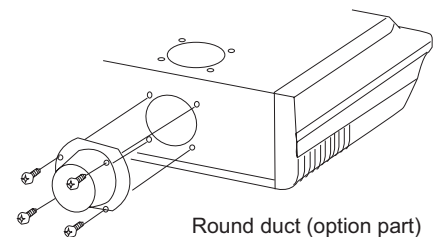
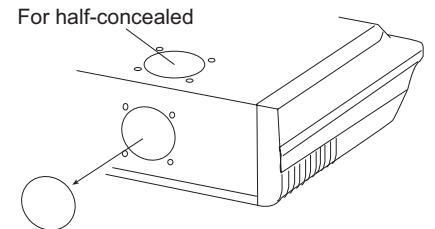

3. Connect the duct to the round flange.

4. Seal with a band and vinyl tape, etc. so that air does not leak from the connection.

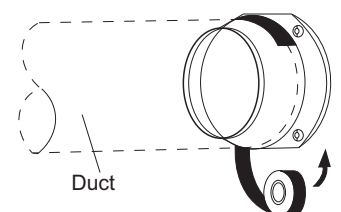

# Test Run

---

## Check items

### 1. Indoor unit

- Is operation of each button on the remote control unit normal?
- Does each lamp light normally?
- Do not air flow direction louvers operate normally?
- Is the drain normal?

### 2. Outdoor unit

- Is there any abnormal noise and vibration during operation?
- Will noise, wind, or drain water from the unit disturb the neighbors?
- Is there any gas leakage?

## Customer guidance

Explain the following to the customer in accordance with the operation manual:

- (1) Starting and stopping method, operation switching, temperature adjustment, timer, air flow switching, and other remote control unit operations.
- (2) Air filter removal and cleaning, and how to use air louvers.
- (3) Give the operation and installation manuals to the customer.





# Haier

Address: Haier Industrial Park, Qianwangang Road, Eco-Tech Development Zone, Qingdao 266555, Shandong, P.R.C.  
Contacts: TEL +86-532-88936943; FAX +86-532-8893-6999  
Website: [www.haier.com](http://www.haier.com)